

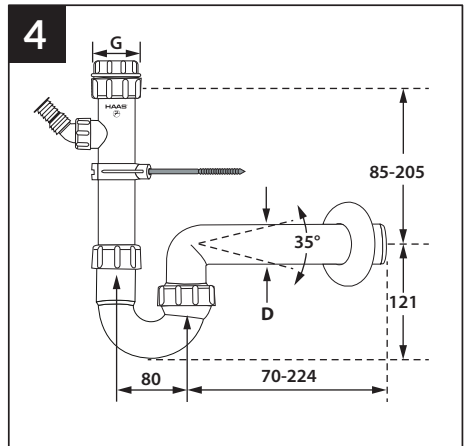

Art. 4970 / DN 40

Art. 4975 / DN 50

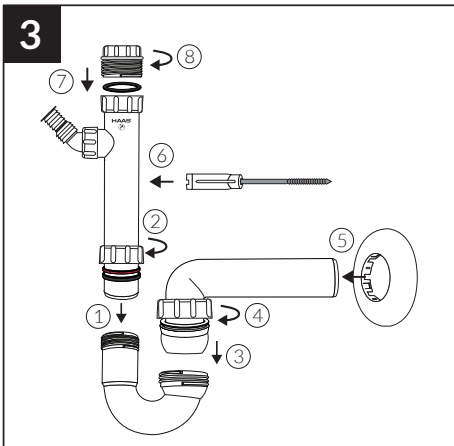
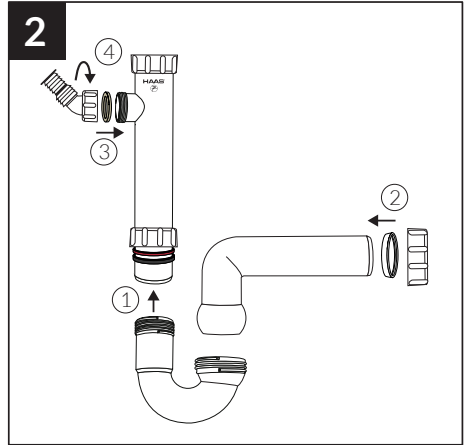
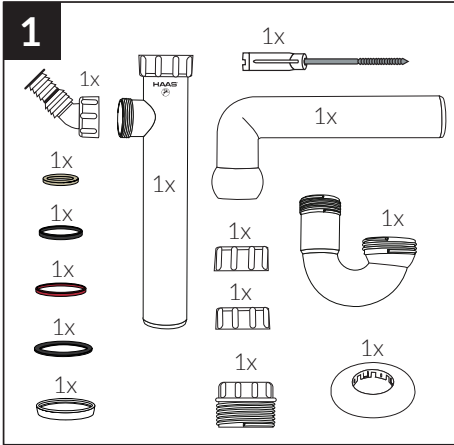

G = 1 1/2"