

Art. 4930 / DN 40 Art. 4935 / DN 50

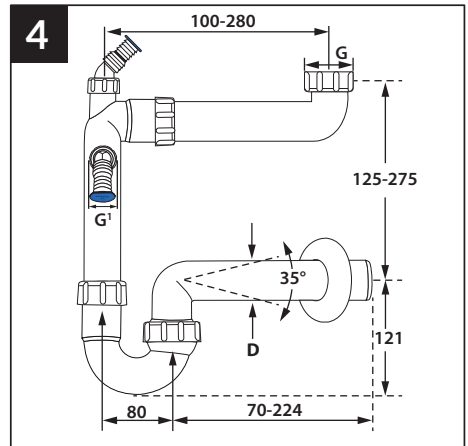
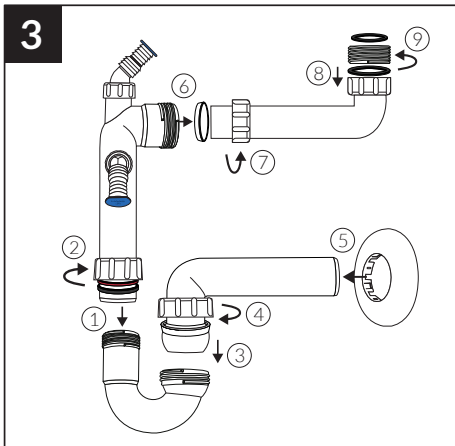
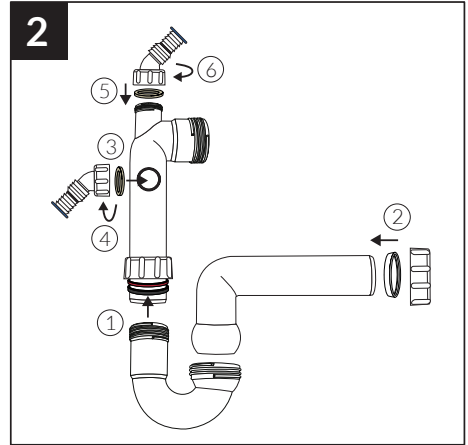
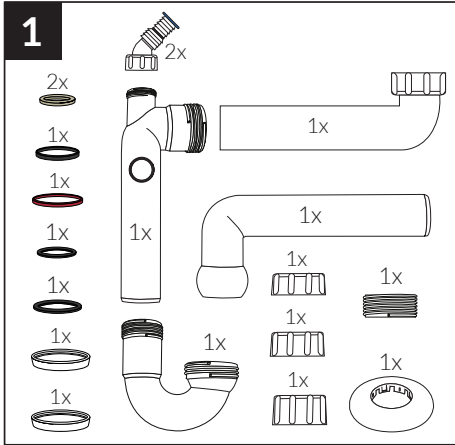

G = 1 ½" auf 1 ¼" möglich