

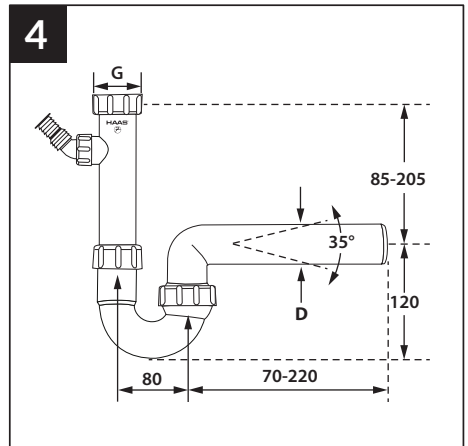

Art. 4855 / DN 40/50

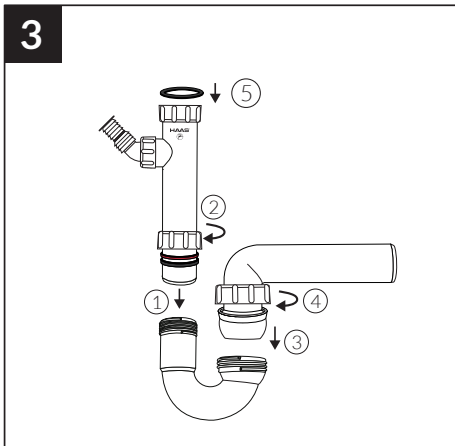
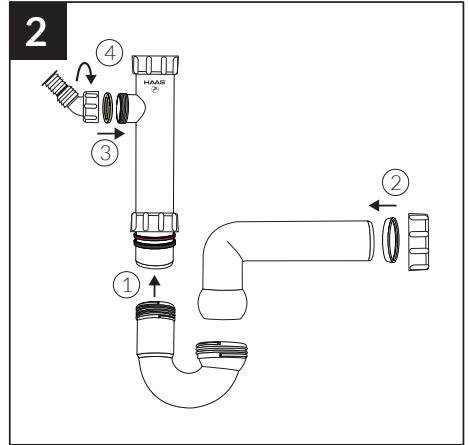
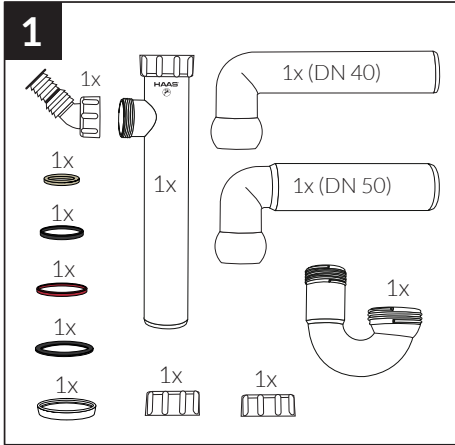

G = 1 1/2"