

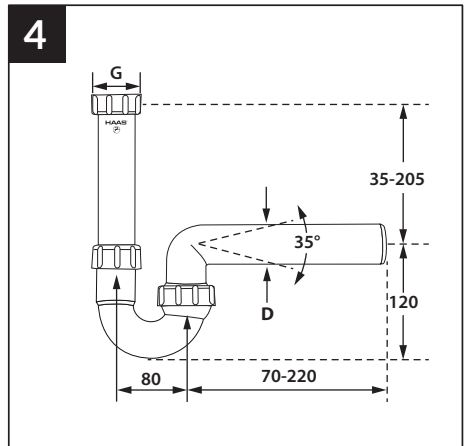

Art. 4810 / DN 40 Art. 4815 / DN 50

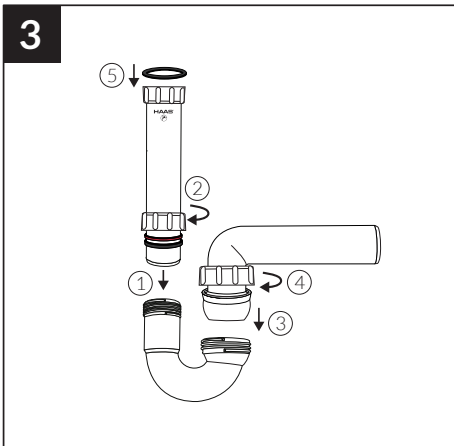
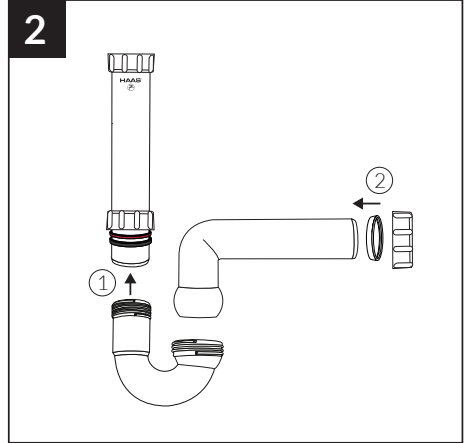
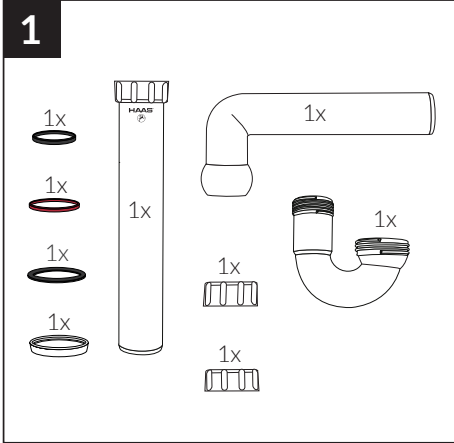

G = 1 1/2"