

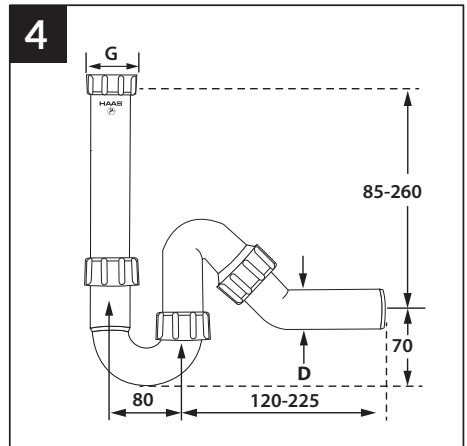

Art. 2982 / DN 40 Art. 2987 / DN 50

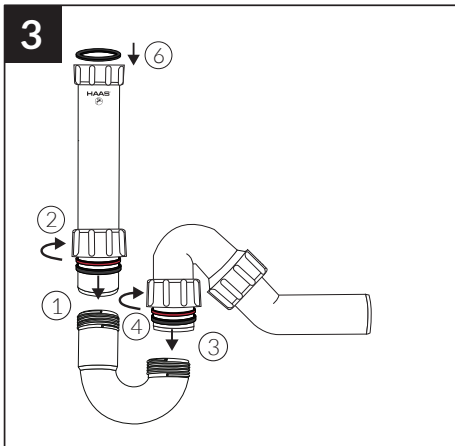
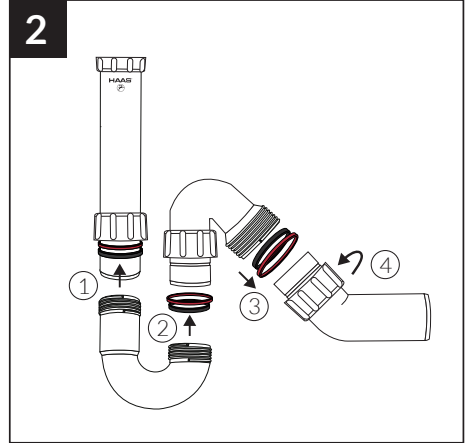
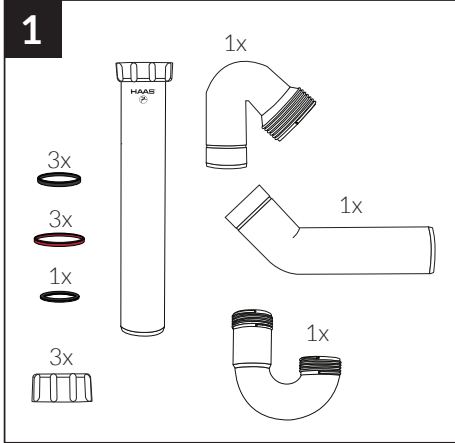

G = 1½"