

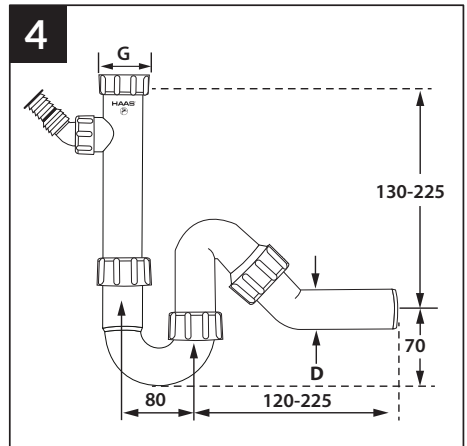

Art. 2980 / DN 40 Art. 2985 / DN 50

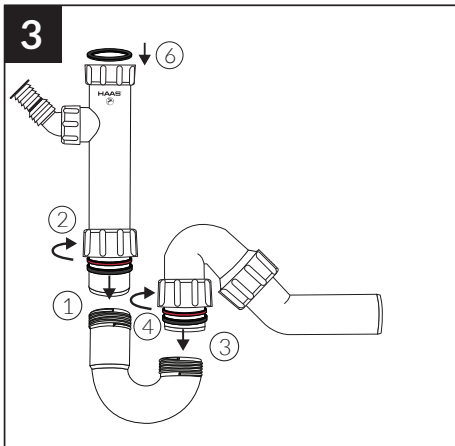
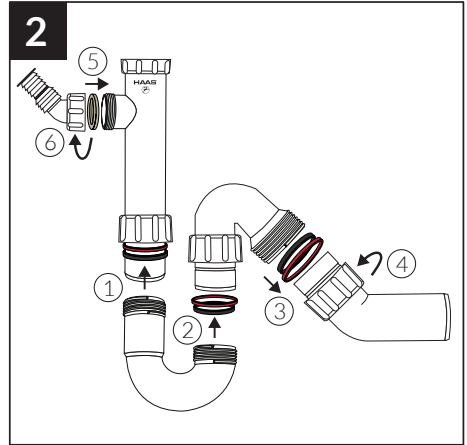
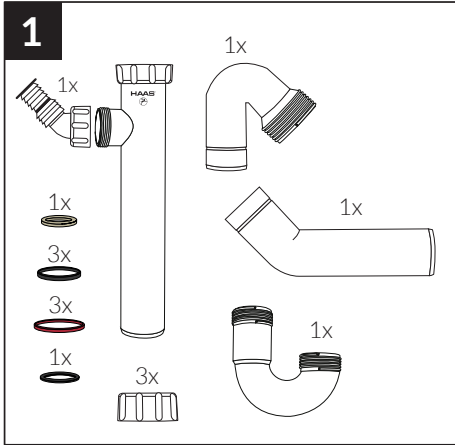

G = 1½"