

Art. 2969

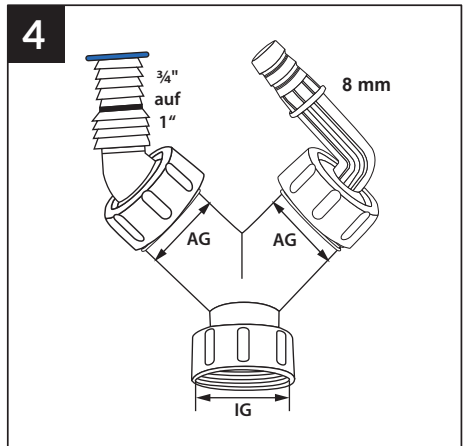
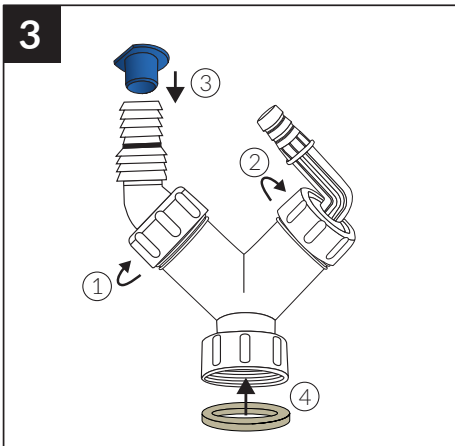
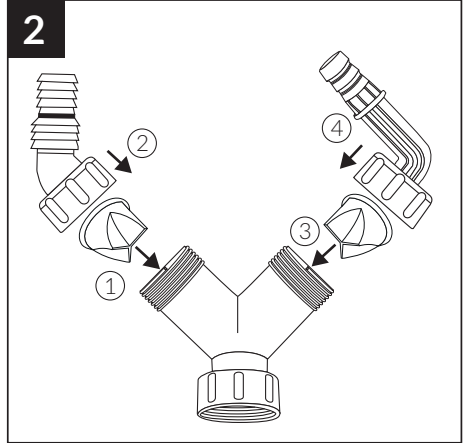
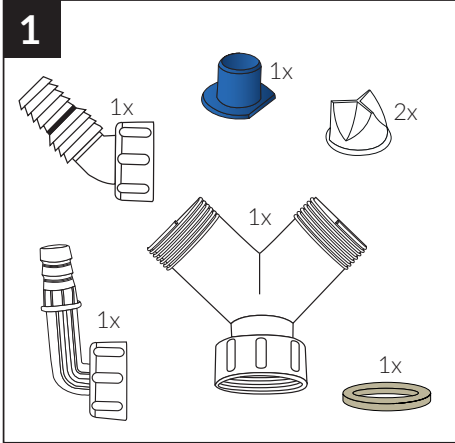

AG = 1"
IG = 1"