

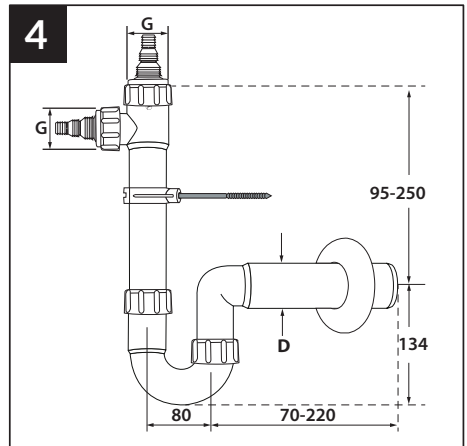

Art. 2930 / DN 40 Art. 2935 / DN 50

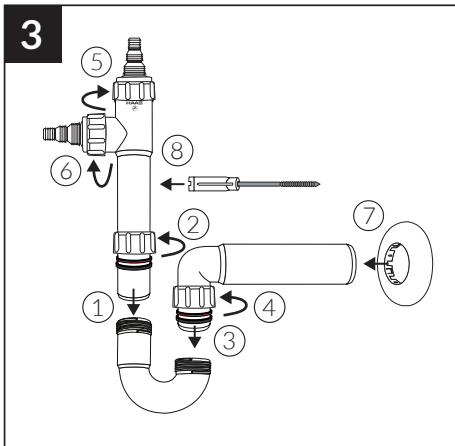
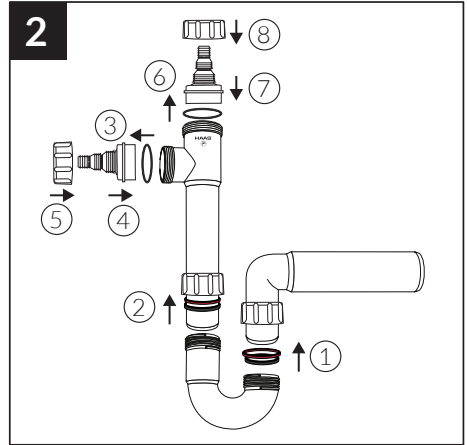
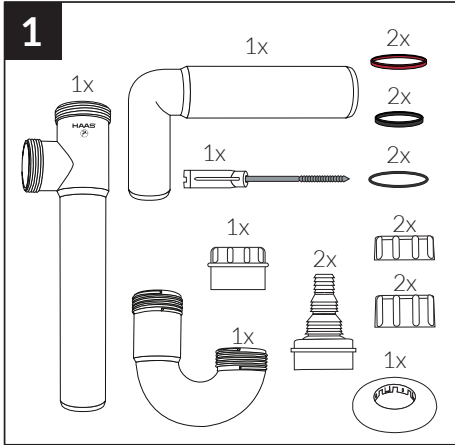

G = 1½"