

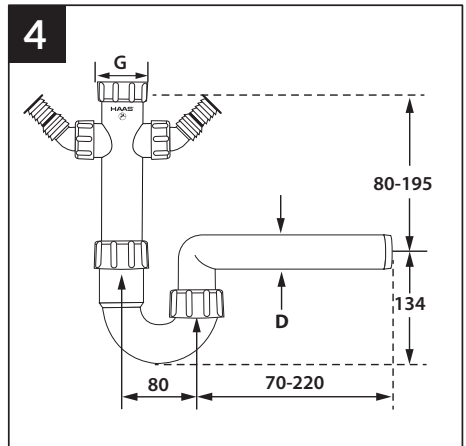

Art. 2920 / DN 40 Art. 2925 / DN 50

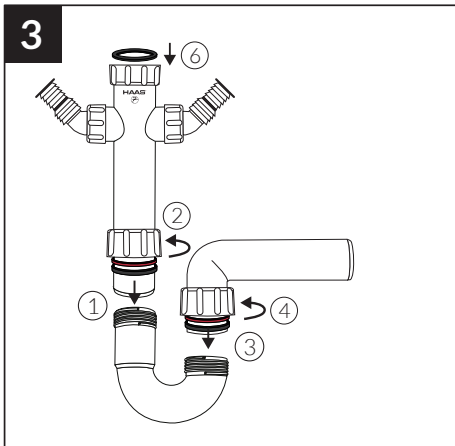
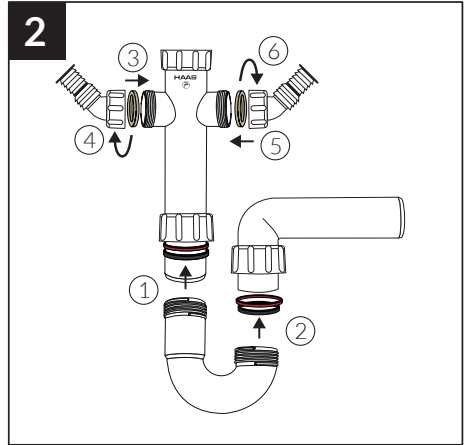
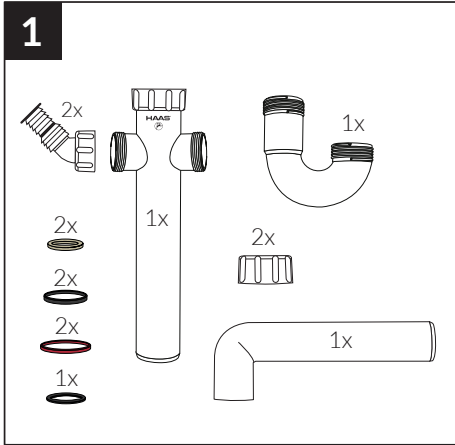

G = 1½"