

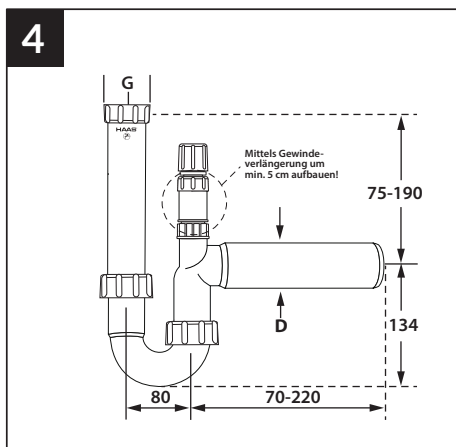

# Art. 2823 / DN 40

# Art. 2824 / DN 50

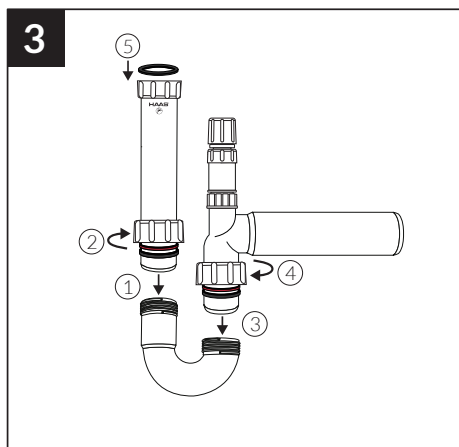
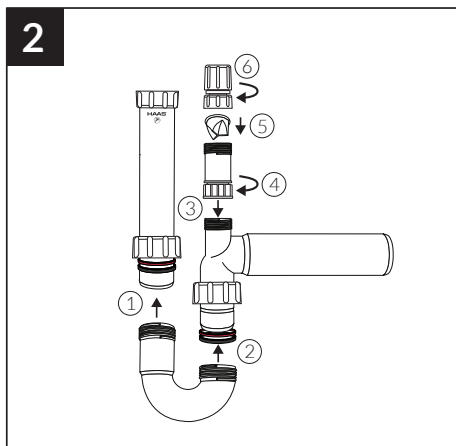
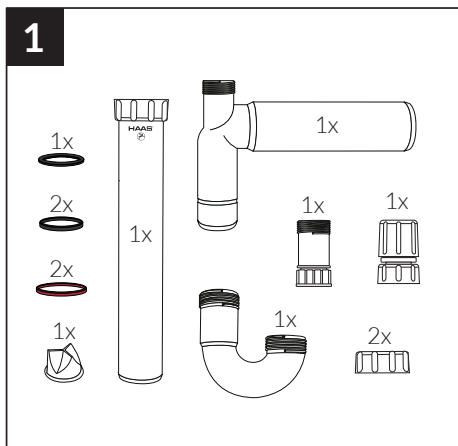

**G = 1½"**