

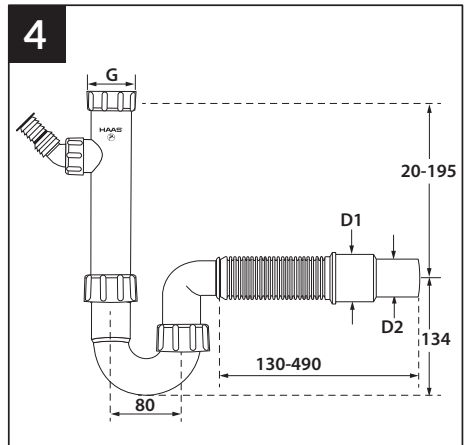

Art. 2805

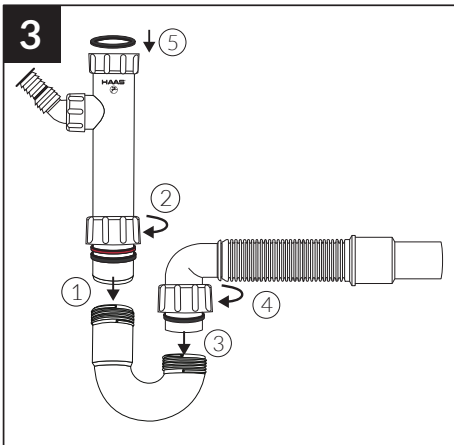
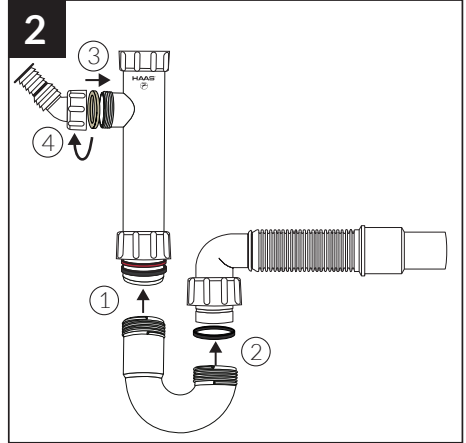
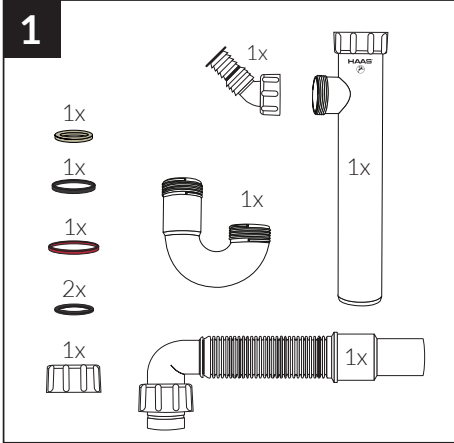

G = 1½"

D1 = 50

D2 = 40