

Art. 1930 / DN 40

Art. 1935 / DN 50

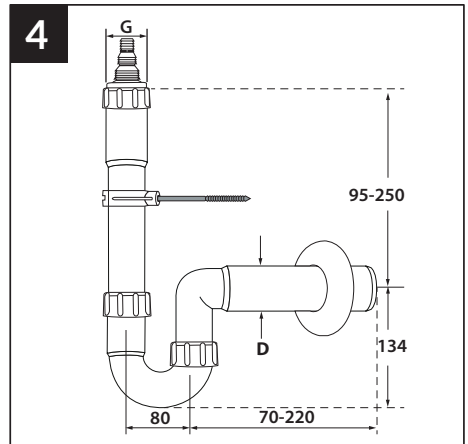
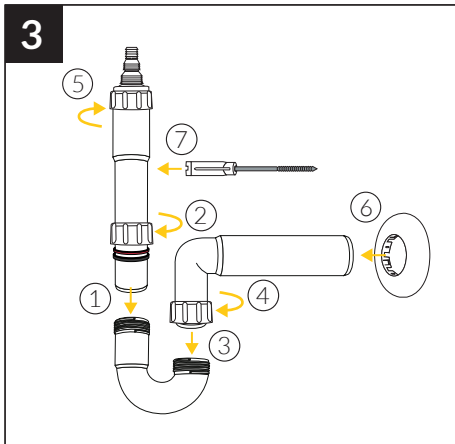
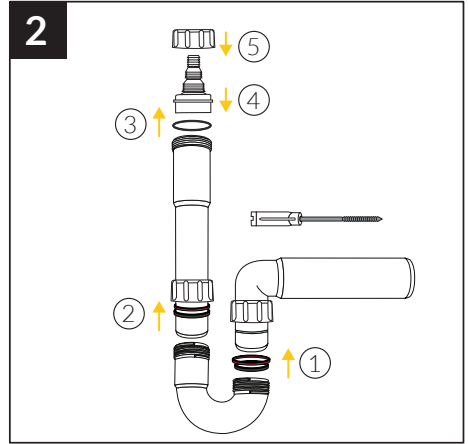
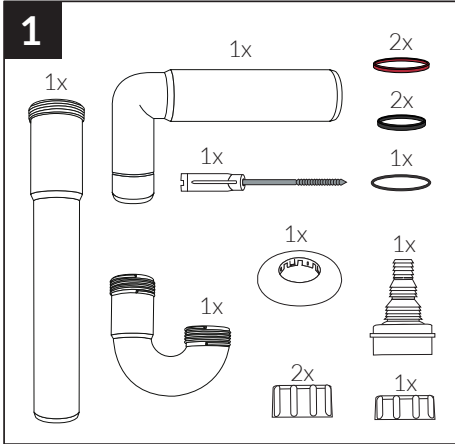

G = 1½"